

Blindstopfen Sechskant – Metrisches Gewinde – Messing

Messing vernickelt

Metrisches Anschlussgewinde nach EN 60423

Mit O-Ring aus HNBR





Schutzart IP 68 bis 10 bar

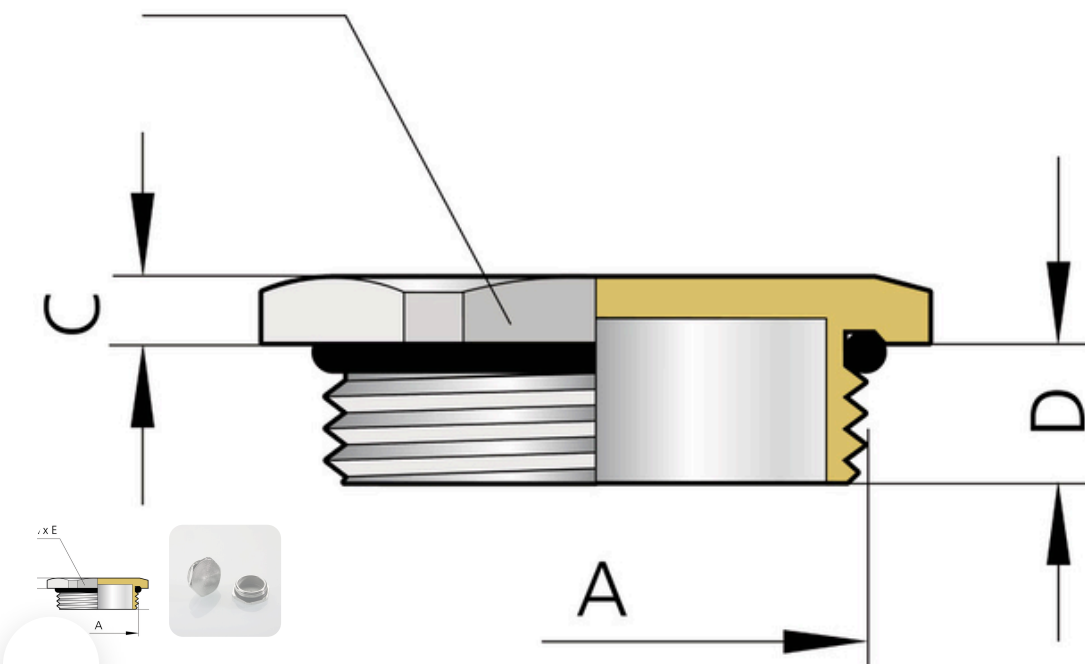

Temperaturbereich: -40 °C bis +150 °C



SW x E



Art.-Nr.	Menge	Nenngröße		Bauhöhe	Schlüsselweite		Konformität
		A	D mm	C mm	SW x E mm		
BSM 12Cr	1	M12x1,5	5,0	3,0	14x15,5	50	RoHS
7212/DR	1	M12x1,5	5,0	3,0	14x15,5	50	RoHS 
87212/6K	1	M12x1,5	5,0	3,0	14x15,5	50	RoHS
7216/DR	1	M16x1,5	6,0	3,0	18x20	50	RoHS 
87216/6K	1	M16x1,5	6,0	3,0	18x20	50	RoHS
BSM 16Cr 9lg	1	M16x1,5	9,0	3,0	18x20	50	RoHS
BSM 18Cr	1	M18x1,5	10,0	5,0	24x26,7	50	RoHS
7220/DR	1	M20x1,5	6,5	3,0	22x24,4	50	RoHS 
87220/6K	1	M20x1,5	6,5	3,0	22x24,4	50	RoHS
BSM 20Cr 10lg	1	M20x1,5	10,0	3,0	22x24,4	50	RoHS
BSM 24Cr	1	M24x1,5	11,0	5,0	30x33,5	50	RoHS
7225/DR	1	M25x1,5	6,5	3,0	28x31,2	50	RoHS 
87225/6K	1	M25x1,5	6,5	3,0	28x31,2	50	RoHS

BSM 25Cr 11lg	1	M25x1,5	11,0	3,0	28x31,2	50	RoHS
BSM 30Cr	1	M30x2	12,0	5,0	35x38,5	50	RoHS
7232/DR	1	M32x1,5	7,0	3,5	35x38,5	50	RoHS 
87232/6K	1	M32x1,5	7,0	3,5	35x38,5	50	RoHS
BSM 32Cr 12lg	1	M32x1,5	12,0	3,5	35x38,5	50	RoHS
BSM 36Cr	1	M36x2	13,0	6,0	40x43,5	25	RoHS
7240/DR	1	M40x1,5	8,0	4,0	43x47,3	25	RoHS 
87240/6K	1	M40x1,5	8,0	4,0	43x47,3	25	RoHS
BSM 40Cr 13lg	1	M40x1,5	13,0	4,0	43x47,3	25	RoHS
BSM 45Cr	1	M45x2	14,0	7,0	50x54	25	RoHS
7250/DR	1	M50x1,5	10,0	7,0	54x58	10	RoHS 
87250/6K	1	M50x1,5	10,0	7,0	54x58	10	RoHS