



Symbolbild

Datenblatt





Artikelnummer: 70019911

Bezeichnung: CA20.A205*A-V751.PNL4

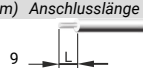
Beschreibung: Schalter

IEC 60947-3 EN 60947-3, VDE 0660 Teil 107						
Bemessungsisolationsspannung Ui						
			Spannung (V) AC / DC			
			690 AC / DC			
Bemessungsdauerstrom Iu/lth						
Strom (A)		Umgebungstemperatur (°C)		Temperaturspitzen (°C) zusätzliche Bedingungen		
25		55		60 Umgebungstemperatur +55°C über 24 Stunden mit Spitzen bis +60°C		
Bemessungsbetriebsstrom Ie						
Gebrauchskategorie			Spannung (V)		Strom (A)	
AC-15			220 - 240		8	
AC-15			380 - 440		5	
Bemessungsbetriebsleistung						
Gebrauchskategorie		Spannung (V)	Phasenanzahl	Polanzahl	Leistung (kW)	
AC-3		220 - 240	3	3	4	
AC-3		380 - 440	3	3	7,50	
AC-3		660 - 690	3	3	7,50	
AC-3		220 - 240	1	2	3	
AC-3		380 - 440	1	2	3,70	
AC-23A		220 - 240	3	3	5,50	
AC-23A		380 - 440	3	3	11	
AC-23A		660 - 690	3	3	11	
AC-23A		220 - 240	1	2	3	
AC-23A		380 - 440	1	2	5,50	
Max. Sicherungsnennstrom IEC						
Sicherungscharakteristik			Sicherungsanzahl		Strom (A)	
gG			1		35	
UL60947-4-1 , UL508						
Nominal Voltage						
			Spannung (V) AC / DC			
			600 AC			
Bemessungsisolationsspannung Ui						
			Spannung (V) AC / DC			
			600 AC			
Rated thermal current						
		Strom (A)		Umgebungstemperatur (°C) Zusatz Text		
		30		0 - 40 --		
Horsepower rating						
Across-the-Line Motor Starting		Spannung (V)	Phasenanzahl	Polanzahl	Leistung (HP)	Umgebungstemperatur [°C]
Reversing		110 - 120	1	2	0,33	40
Reversing		220 - 240	1	2	0,75	40
Reversing		277 - 277	1	2	1	40
Reversing		415 - 415	1	2	1,50	40
Reversing		440 - 480	1	2	2	40
Reversing		550 - 600	1	2	2	40
Reversing		110 - 120	3	3	1	40
Reversing		220 - 240	3	3	2	40
Reversing		415 - 415	3	3	3	40
Reversing		440 - 480	3	3	5	40
Reversing		550 - 600	3	3	5	40
DOL		110 - 120	1	2	1,50	40
DOL		220 - 240	1	2	3	40
DOL		277 - 277	1	2	3	40
DOL		415 - 415	1	2	3	40
DOL		440 - 480	1	2	5	40
DOL		550 - 600	1	2	5	40
DOL		110 - 120	3	3	3	40
DOL		220 - 240	3	3	7,50	40
DOL		415 - 415	3	3	7,50	40
DOL		440 - 480	3	3	10	40

Horsepower rating						
<i>Across-the-Line Motor Starting</i>						
DOL	Spannung (V)	Phasenanzahl	Polanzahl	Leistung (HP)	Umgebungstemperatur [°C]	
	550 - 600	3	3	10	40	
Pilot duty rating code						
<i>Duty Code</i>						
A600						
SCCR / Max. Vorsicherung						
<i>Conditions of acceptability</i>						
These devices are suitable for use on circuits capable of delivering not more than 5000 rms symmetrical amperes, 600V ac max. when protected by Class RK1 fuses. Manual Motor Controllers when intended for use as a motor disconnect are suitable for use on a circuit capable of delivering not more than 5000 rms symmetrical amperes, 600V ac max. when protected by 30A Class J time delay fuses.						
Temp. rating of wire						
Temperature Rating (°C)			Strom (A) Text			
75			– Use copper wire only			
Anschlussbestimmungen						
<i>Markings</i>						
When intended for use as a motor disconnect the device shall be provided with a method of being locked in the OFF-position.						
General Use						
AC / DC	Spannung (V)	Strom (A)	Phasenanzahl	Polanzahl	Anzahl der Kontakte in Serie	
AC	600	30	1	2	1	
AC	600	30	3	3	1	
CSA						
Nominal Voltage						
			Spannung (V) AC / DC			
			600 AC			
Bemessungsisolationsspannung Ui						
			Spannung (V) AC / DC			
			600 AC			
Rated thermal current						
		Strom (A)		Umgebungstemperatur (°C) Zusatz Text		
		30		0 - 40 –		
Horsepower rating						
<i>Across-the-Line Motor Starting</i>						
DOL	Spannung (V)	Phasenanzahl	Polanzahl	Leistung (HP)	Umgebungstemperatur [°C]	
DOL	110 - 120	1	2	1,50	40	
DOL	220 - 240	1	2	3	40	
DOL	277 - 277	1	2	3	40	
DOL	415 - 415	1	2	5	40	
DOL	440 - 480	1	2	5	40	
DOL	550 - 600	1	2	5	40	
DOL	110 - 120	3	3	3	40	
DOL	220 - 240	3	3	7,50	40	
DOL	415 - 415	3	3	10	40	
DOL	440 - 480	3	3	10	40	
DOL	550 - 600	3	3	10	40	
Pilot duty rating code						
<i>Duty Code</i>						
A600						
Temp. rating of wire						
Temperature Rating (°C)			Strom (A) Text			
75			– only			
General Use						
AC / DC	Spannung (V)	Strom (A)	Phasenanzahl	Polanzahl	Anzahl der Kontakte in Serie	
AC	600	30	1	1	1	
GENERAL TECHNICAL INFORMATION						
Leiterquerschnitt						
<i>Leiteraufbau</i>	<i>Min. / Max. Wert</i>		<i>Anzahl der Leiter pro Klemme</i>	<i>Drahtquerschnitt (-bereich) (mm²) oder (AWG/kcmil)</i>		<i>Drahtmaterial</i>
eindräftig	Min.		1	0,75mm ²		Kupfer
eindräftig	Min.		2	0,75mm ²		Kupfer
feindräftig	Min.		1	1,5mm ²		Kupfer
feindräftig	Max.		2	AWG 12		Kupfer
feindräftig	Max.		2	4mm ²		Kupfer
feindräftig	Min.		2	1,5mm ²		Kupfer
ein- bzw. mehrdräftig	Max.		2	AWG 10		Kupfer
ein- bzw. mehrdräftig	Max.		2	4mm ²		Kupfer
feindräftig mit Aderendhülsen nach DIN 46228	Min.		1	1mm ²		Kupfer
feindräftig mit Aderendhülsen nach DIN 46228	Max.		2	2,5mm ²		Kupfer
feindräftig mit Aderendhülsen nach DIN 46228	Min.		2	1mm ²		Kupfer
Abisolierlänge des Leiters						
			Länge (mm) Anschlusslänge - Bild			
						
Empfohlene Schraubendreher						
<i>Schraubendreherart</i>			Wert			
Kreuzschlitz - Schraubendreher			PH1			
Schlitzschraubendreher nach DIN 5264			0,8x5,5			
Klemmschraube						
			Anzugsdrehmoment (Nm)		Anzugsdrehmoment (lb-in)	
			1		9	

Approbationen	Marking
Specification	
EAC	
CE marking	
UK Directives	
CSA C.22.2 No.14	
GB/T14048.3	

Allgemeine Informationen
Text
<ul style="list-style-type: none"> - Die Schaltgeräte sind wartungsfrei. Schmierung oder Behandlung von Kontakten ist zu unterlassen. - Die Schalter dürfen nur von Fachkräften und nach den anerkannten Regeln der Technik eingebaut, angeschlossen und in Betrieb genommen werden. - Nur Kupferleitungen verwenden. Leiterenden nicht verzinnen. - Klemmen mit werksseitig angeschlossenen Verbindungslaschen bzw. Drahtverbindungen werden verschraubt geliefert. Nach dem Öffnen solcher Klemmen ist darauf zu achten, dass keine Verbindungslaschen verloren gehen, alle Drahtverbindungen wieder korrekt sitzen und die Klemmschrauben mit dem angegebenen Drehmoment wieder festgezogen werden. - Nach Installation der Schalter müssen die Kriech- und Luftstrecken im Bereich der Anschlussklemmen den Anforderungen der anwendbaren Norm und Vorschriften entsprechen.

Waste Electrical & Electronic Equipment (WEEE)	
Picture name	Description
	Nicht in den Müll werfen, da auf eine umweltgerechte Entsorgung und Wiederverwertung geachtet werden muss. Bitte wenden Sie sich entweder an ein umweltfreundliches Entsorgungsunternehmen; senden Sie es zur Entsorgung an den Lieferanten oder direkt an den Hersteller Kraus & Naimer zurück. Lokale Kraus & Naimer Ansprechpartner finden Sie unter www.krausnaimer.com

Proposition 65	
Bildname	Beschreibung
	WARNING: This product can expose you to chemicals including nickel and lead, which is known to the State of California to cause cancer. For more information go to www.P65Warnings.ca.gov .

Kontakttype: Starre Kontaktbrücke
Kontaktmaterial: Silber
Anschluss: Schraubanschluss

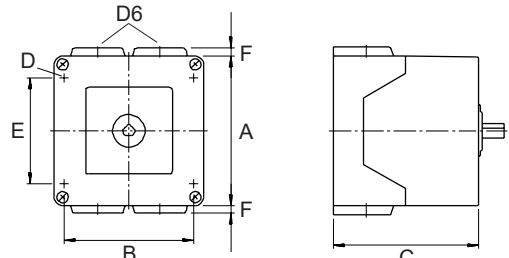
Bauform-PNL4	
	
IP - Schutzart Front	IP42
Fluchten	1,00 - 2,00
A	□ 82,00 mm
B	H 68,00 mm
C	H 59,70 mm
D	∅ 4,40 mm
D6	∅ 4,00 x M25
E	H 52,00 mm
F	H 5,00 mm

Anschlussbild

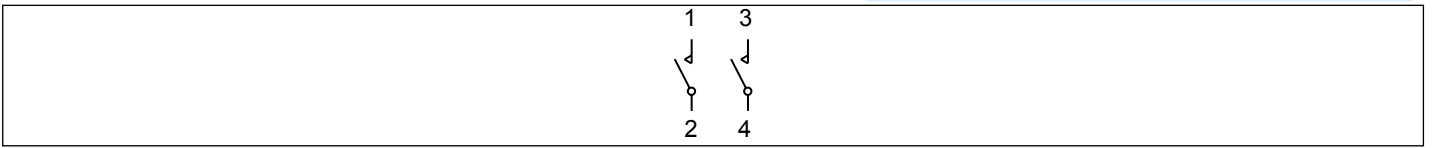

CA20.A205.PNL4



Schaltprogramm

CA20.A205.PNL4

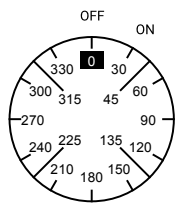
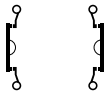
 Kraus & Naimer

		CA20				A205				Seite 1 von 1			
Frontschild													
		1	3	5	7	9	11	13	15	17	19	21	23
													
Schaltwinkel	<input type="text" value="90"/>	2	4	6	8	10	12	14	16	18	20	22	24
Gesamtschaltwinkel	<input type="text" value="30"/>												
	OFF	0											
		15											
	ON	30											
		45											
		60											
		75											
		90											
		105											
		120											
		135											
		150											
		165											
		180											
		195											
		210											
		225											
		240											
		255											
		270											
		285											
		300											
		315											
		330											
		345											

Version: 67

Frontschild

S1.F169/A10.V45

