



Symbolbild



Datenblatt



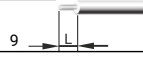

Artikelnummer: 70005744

Bezeichnung: CA20.A400.E

Beschreibung: Schalter

IEC 60947-3 EN 60947-3, VDE 0660 Teil 107							
Bemessungsisolationsspannung Ui							
Spannung (V) AC / DC							
690 AC / DC							
Bemessungsdauerstrom Iu/Ith							
Strom (A)	Umgebungstemperatur (°C)	Temperaturspitzen (°C)	zusätzliche Bedingungen				
25	55	60	Umgebungstemperatur +55°C über 24 Stunden mit Spitzen bis +60°C				
Bemessungsbetriebsstrom Ie							
Gebrauchskategorie							
Spannung (V)						Strom (A)	
AC-15						220 - 240	8
AC-15						380 - 440	5
Bemessungsbetriebsleistung							
Gebrauchskategorie							
	Spannung (V)	Phasenanzahl	Polanzahl	Leistung (kW)			
AC-3	220 - 240	3	3	4			
AC-3	380 - 440	3	3	7,50			
AC-3	660 - 690	3	3	7,50			
AC-3	220 - 240	1	2	3			
AC-3	380 - 440	1	2	3,70			
AC-23A	220 - 240	3	3	5,50			
AC-23A	380 - 440	3	3	11			
AC-23A	660 - 690	3	3	11			
AC-23A	220 - 240	1	2	3			
AC-23A	380 - 440	1	2	5,50			
Max. Sicherungsnennstrom IEC							
Sicherungscharakteristik							
Sicherungsanzahl						Strom (A)	
gG						1	35
UL60947-4-1 , UL508							
Nominal Voltage							
Spannung (V) AC / DC							
600 AC							
Bemessungsisolationsspannung Ui							
Spannung (V) AC / DC							
600 AC							
Rated thermal current							
Strom (A)							
30							
Umgebungstemperatur (°C) Zusatz Text							
0 - 40 --							
Horsepower rating							
Across-the-Line Motor Starting							
	Spannung (V)	Phasenanzahl	Polanzahl	Leistung (HP)	Umgebungstemperatur [°C]		
Reversing	110 - 120	1	2	0,33	40		
Reversing	220 - 240	1	2	0,75	40		
Reversing	277 - 277	1	2	1	40		
Reversing	415 - 415	1	2	1,50	40		
Reversing	440 - 480	1	2	2	40		
Reversing	550 - 600	1	2	2	40		
Reversing	110 - 120	3	3	1	40		
Reversing	220 - 240	3	3	2	40		
Reversing	415 - 415	3	3	3	40		
Reversing	440 - 480	3	3	5	40		
Reversing	550 - 600	3	3	5	40		
DOL	110 - 120	1	2	1,50	40		
DOL	220 - 240	1	2	3	40		
DOL	277 - 277	1	2	3	40		
DOL	415 - 415	1	2	3	40		
DOL	440 - 480	1	2	5	40		
DOL	550 - 600	1	2	5	40		
DOL	110 - 120	3	3	3	40		
DOL	220 - 240	3	3	7,50	40		
DOL	415 - 415	3	3	7,50	40		
DOL	440 - 480	3	3	10	40		
DOL	550 - 600	3	3	10	40		

Pilot duty rating code						
Duty Code						
A600						
SCCR / Max. Vorsicherung						
Conditions of acceptability						
These devices are suitable for use on circuits capable of delivering not more than 5000 rms symmetrical amperes, 600V ac max. when protected by Class RK1 fuses. Manual Motor Controllers when intended for use as a motor disconnect are suitable for use on a circuit capable of delivering not more than 5000 rms symmetrical amperes, 600V ac max. when protected by 30A Class J time delay fuses.						
Temp. rating of wire						
Temperature Rating (°C)			Strom (A) Text			
75			– Use copper wire only			
Anschlussbestimmungen						
Markings						
When intended for use as a motor disconnect the device shall be provided with a method of being locked in the OFF-position.						
General Use						
AC / DC	Spannung (V)	Strom (A)	Phasenanzahl	Polanzahl	Anzahl der Kontakte in Serie	
AC	600	30	1	2	1	
AC	600	30	3	3	1	
CSA						
Nominal Voltage						
			Spannung (V) AC / DC			
			600 AC			
Bemessungsisolationsspannung Ui						
			Spannung (V) AC / DC			
			600 AC			
Rated thermal current						
		Strom (A)		Umgebungstemperatur (°C) Zusatz Text		
		30		0 - 40 –		
Horsepower rating						
Across-the-Line Motor Starting						
	Spannung (V)	Phasenanzahl	Polanzahl	Leistung (HP)	Umgebungstemperatur [°C]	
DOL	110 - 120	1	2	1,50	40	
DOL	220 - 240	1	2	3	40	
DOL	277 - 277	1	2	3	40	
DOL	415 - 415	1	2	5	40	
DOL	440 - 480	1	2	5	40	
DOL	550 - 600	1	2	5	40	
DOL	110 - 120	3	3	3	40	
DOL	220 - 240	3	3	7,50	40	
DOL	415 - 415	3	3	10	40	
DOL	440 - 480	3	3	10	40	
DOL	550 - 600	3	3	10	40	
Pilot duty rating code						
Duty Code						
A600						
Temp. rating of wire						
Temperature Rating (°C)			Strom (A) Text			
75			– only			
General Use						
AC / DC	Spannung (V)	Strom (A)	Phasenanzahl	Polanzahl	Anzahl der Kontakte in Serie	
AC	600	30	1	1	1	
GENERAL TECHNICAL INFORMATION						
Leiterquerschnitt						
Leiteraufbau	Min. / Max. Wert	Anzahl der Leiter pro Klemme		Drahtquerschnitt (-bereich) (mm ²) oder (AWG/kcmil)	Drahtmaterial	
eindräftig	Min.			1 0,75mm ²	Kupfer	
eindräftig	Min.			2 0,75mm ²	Kupfer	
feindräftig	Min.			1 1,5mm ²	Kupfer	
feindräftig	Max.			2 AWG 12	Kupfer	
feindräftig	Max.			2 4mm ²	Kupfer	
feindräftig	Min.			2 1,5mm ²	Kupfer	
ein- bzw. mehrdräftig	Max.			2 AWG 10	Kupfer	
ein- bzw. mehrdräftig	Max.			2 4mm ²	Kupfer	
feindräftig mit Aderendhülsen nach DIN 46228	Min.			1 1mm ²	Kupfer	
feindräftig mit Aderendhülsen nach DIN 46228	Max.			2 2,5mm ²	Kupfer	
feindräftig mit Aderendhülsen nach DIN 46228	Min.			2 1mm ²	Kupfer	
Abisolierlänge des Leiters						
			Länge (mm) Anschlusslänge - Bild			
						
Empfohlene Schraubendreher						
Schraubendreherart			Wert			
Kreuzschlitz - Schraubendreher			PH1			
Schlitzschraubendreher nach DIN 5264			0,8x5,5			
Klemmschraube						
			Anzugsdrehmoment (Nm)		Anzugsdrehmoment (lb-in)	
			1		9	
Approbationen						
Specification						Marking
EAC						

Approbationen	Marking
Specification	
CE marking	
UK Directives	
CSA C.22.2 No.14	
GB/T14048.3	

Allgemeine Informationen

Text

- Die Schaltgeräte sind wartungsfrei. Schmierung oder Behandlung von Kontakten ist zu unterlassen.
- Die Schalter dürfen nur von Fachkräften und nach den anerkannten Regeln der Technik eingebaut, angeschlossen und in Betrieb genommen werden.
- Nur Kupferleitungen verwenden. Leiterenden nicht verzinnen.
- Klemmen mit werksseitig angeschlossenen Verbindungslaschen bzw. Drahtverbindungen werden verschraubt geliefert. Nach dem Öffnen solcher Klemmen ist darauf zu achten, dass keine Verbindungslaschen verloren gehen, alle Drahtverbindungen wieder korrekt sitzen und die Klemmschrauben mit dem angegebenen Drehmoment wieder festgezogen werden.
- Nach Installation der Schalter müssen die Kriech- und Luftstrecken im Bereich der Anschlussklemmen den Anforderungen der anwendbaren Norm und Vorschriften entsprechen.

Waste Electrical & Electronic Equipment (WEEE)

Picture name *Description*

 Nicht in den Müll werfen, da auf eine umweltgerechte Entsorgung und Wiederverwertung geachtet werden muss. Bitte wenden Sie sich entweder an ein umweltfreundliches Entsorgungsunternehmen, senden Sie es zur Entsorgung an den Lieferanten oder direkt an den Hersteller Kraus & Naimer zurück. Lokale Kraus & Naimer Ansprechpartner finden Sie unter www.krausnaimer.com

Proposition 65

Bildname *Beschreibung*

 WARNING: This product can expose you to chemicals including nickel and lead, which is known to the State of California to cause cancer. For more information go to www.P65Warnings.ca.gov.

Kontakttype: Starre Kontaktbrücke
 Kontaktmaterial: Silber
 Anschluss: Schraubanschluss

Bauform-E

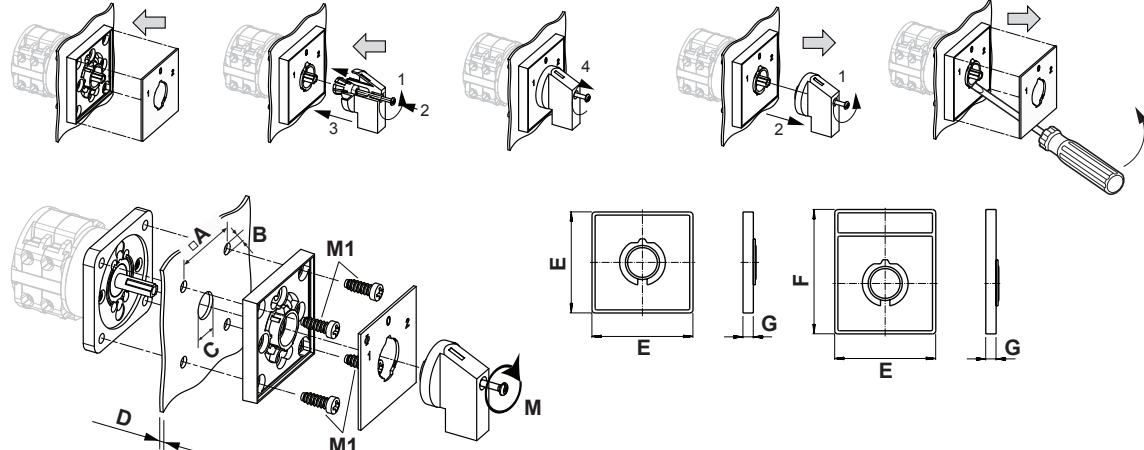

IP - Schutzart Front		IP40
Fluchten		1,00 - 12,00
A	□	36,00 mm
B	∅	5,00 mm
C	∅	8,00 - 19,00 mm
D	H	<= 4,00 mm
E	H	48,00 mm
F	H	59,00 mm
G	H	6,70 mm
M	\vec{M}	0,50 Nm
M1	\vec{M}	0,90 Nm

Anschlussbild

CA20.A400.E

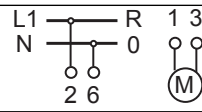

Schaltprogramm

CA20.A400.E

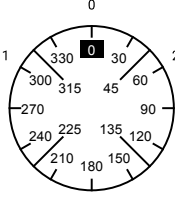
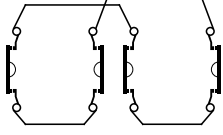
 Kraus & Naimer		CA20		A400		Seite 1 von 1																																																																																																																																																																																																																																																																																																																																																																																																																																																																																																																																																																			
		Frontschild																																																																																																																																																																																																																																																																																																																																																																																																																																																																																																																																																																							
																																																																																																																																																																																																																																																																																																																																																																																																																																																																																																																																																																									
		<table border="1"> <tr> <td>1</td><td>3</td><td>5</td><td>7</td><td>9</td><td>11</td><td>13</td><td>15</td><td>17</td><td>19</td><td>21</td><td>23</td> </tr> <tr> <td>2</td><td>4</td><td>6</td><td>8</td><td>10</td><td>12</td><td>14</td><td>16</td><td>18</td><td>20</td><td>22</td><td>24</td> </tr> </table>												1	3	5	7	9	11	13	15	17	19	21	23	2	4	6	8	10	12	14	16	18	20	22	24																																																																																																																																																																																																																																																																																																																																																																																																																																																																																																																																				
1	3	5	7	9	11	13	15	17	19	21	23																																																																																																																																																																																																																																																																																																																																																																																																																																																																																																																																																														
2	4	6	8	10	12	14	16	18	20	22	24																																																																																																																																																																																																																																																																																																																																																																																																																																																																																																																																																														
Schaltwinkel <input type="text" value="60"/> Gesamtschaltwinkel <input type="text" value="120"/>																																																																																																																																																																																																																																																																																																																																																																																																																																																																																																																																																																									
<table border="1"> <tr><td>1</td><td>300</td><td></td><td>■</td><td>■</td><td></td><td></td><td></td><td></td><td></td><td></td><td></td><td></td><td></td><td></td><td></td><td></td><td></td><td></td><td></td><td></td><td></td><td></td></tr> <tr><td></td><td>315</td><td></td><td></td><td></td><td></td><td></td><td></td><td></td><td></td><td></td><td></td><td></td><td></td><td></td><td></td><td></td><td></td><td></td><td></td><td></td><td></td><td></td></tr> <tr><td></td><td>330</td><td></td><td></td><td></td><td></td><td></td><td></td><td></td><td></td><td></td><td></td><td></td><td></td><td></td><td></td><td></td><td></td><td></td><td></td><td></td><td></td><td></td></tr> <tr><td></td><td>345</td><td></td><td></td><td></td><td></td><td></td><td></td><td></td><td></td><td></td><td></td><td></td><td></td><td></td><td></td><td></td><td></td><td></td><td></td><td></td><td></td><td></td></tr> <tr><td>0</td><td>0</td><td></td><td></td><td></td><td></td><td></td><td></td><td></td><td></td><td></td><td></td><td></td><td></td><td></td><td></td><td></td><td></td><td></td><td></td><td></td><td></td><td></td></tr> <tr><td></td><td>15</td><td></td><td></td><td></td><td></td><td></td><td></td><td></td><td></td><td></td><td></td><td></td><td></td><td></td><td></td><td></td><td></td><td></td><td></td><td></td><td></td><td></td></tr> <tr><td></td><td>30</td><td></td><td></td><td></td><td></td><td></td><td></td><td></td><td></td><td></td><td></td><td></td><td></td><td></td><td></td><td></td><td></td><td></td><td></td><td></td><td></td><td></td></tr> <tr><td></td><td>45</td><td></td><td></td><td></td><td></td><td></td><td></td><td></td><td></td><td></td><td></td><td></td><td></td><td></td><td></td><td></td><td></td><td></td><td></td><td></td><td></td><td></td></tr> <tr><td>2</td><td>60</td><td>■</td><td></td><td></td><td></td><td>■</td><td></td><td></td><td></td><td></td><td></td><td></td><td></td><td></td><td></td><td></td><td></td><td></td><td></td><td></td><td></td><td></td></tr> <tr><td></td><td>75</td><td></td><td></td><td></td><td></td><td></td><td></td><td></td><td></td><td></td><td></td><td></td><td></td><td></td><td></td><td></td><td></td><td></td><td></td><td></td><td></td><td></td></tr> <tr><td></td><td>90</td><td></td><td></td><td></td><td></td><td></td><td></td><td></td><td></td><td></td><td></td><td></td><td></td><td></td><td></td><td></td><td></td><td></td><td></td><td></td><td></td><td></td></tr> <tr><td></td><td>105</td><td></td><td></td><td></td><td></td><td></td><td></td><td></td><td></td><td></td><td></td><td></td><td></td><td></td><td></td><td></td><td></td><td></td><td></td><td></td><td></td><td></td></tr> <tr><td></td><td>120</td><td></td><td></td><td></td><td></td><td></td><td></td><td></td><td></td><td></td><td></td><td></td><td></td><td></td><td></td><td></td><td></td><td></td><td></td><td></td><td></td><td></td></tr> <tr><td></td><td>135</td><td></td><td></td><td></td><td></td><td></td><td></td><td></td><td></td><td></td><td></td><td></td><td></td><td></td><td></td><td></td><td></td><td></td><td></td><td></td><td></td><td></td></tr> <tr><td></td><td>150</td><td></td><td></td><td></td><td></td><td></td><td></td><td></td><td></td><td></td><td></td><td></td><td></td><td></td><td></td><td></td><td></td><td></td><td></td><td></td><td></td><td></td></tr> <tr><td></td><td>165</td><td></td><td></td><td></td><td></td><td></td><td></td><td></td><td></td><td></td><td></td><td></td><td></td><td></td><td></td><td></td><td></td><td></td><td></td><td></td><td></td><td></td></tr> <tr><td></td><td>180</td><td></td><td></td><td></td><td></td><td></td><td></td><td></td><td></td><td></td><td></td><td></td><td></td><td></td><td></td><td></td><td></td><td></td><td></td><td></td><td></td><td></td></tr> <tr><td></td><td>195</td><td></td><td></td><td></td><td></td><td></td><td></td><td></td><td></td><td></td><td></td><td></td><td></td><td></td><td></td><td></td><td></td><td></td><td></td><td></td><td></td><td></td></tr> <tr><td></td><td>210</td><td></td><td></td><td></td><td></td><td></td><td></td><td></td><td></td><td></td><td></td><td></td><td></td><td></td><td></td><td></td><td></td><td></td><td></td><td></td><td></td><td></td></tr> <tr><td></td><td>225</td><td></td><td></td><td></td><td></td><td></td><td></td><td></td><td></td><td></td><td></td><td></td><td></td><td></td><td></td><td></td><td></td><td></td><td></td><td></td><td></td><td></td></tr> <tr><td></td><td>240</td><td></td><td></td><td></td><td></td><td></td><td></td><td></td><td></td><td></td><td></td><td></td><td></td><td></td><td></td><td></td><td></td><td></td><td></td><td></td><td></td><td></td></tr> <tr><td></td><td>255</td><td></td><td></td><td></td><td></td><td></td><td></td><td></td><td></td><td></td><td></td><td></td><td></td><td></td><td></td><td></td><td></td><td></td><td></td><td></td><td></td><td></td></tr> <tr><td></td><td>270</td><td></td><td></td><td></td><td></td><td></td><td></td><td></td><td></td><td></td><td></td><td></td><td></td><td></td><td></td><td></td><td></td><td></td><td></td><td></td><td></td><td></td></tr> <tr><td></td><td>285</td><td></td><td></td><td></td><td></td><td></td><td></td><td></td><td></td><td></td><td></td><td></td><td></td><td></td><td></td><td></td><td></td><td></td><td></td><td></td><td></td><td></td></tr> </table>		1	300		■	■																				315																							330																							345																						0	0																							15																							30																							45																						2	60	■				■																		75																							90																							105																							120																							135																							150																							165																							180																							195																							210																							225																							240																							255																							270																							285																					
1	300		■	■																																																																																																																																																																																																																																																																																																																																																																																																																																																																																																																																																																					
	315																																																																																																																																																																																																																																																																																																																																																																																																																																																																																																																																																																								
	330																																																																																																																																																																																																																																																																																																																																																																																																																																																																																																																																																																								
	345																																																																																																																																																																																																																																																																																																																																																																																																																																																																																																																																																																								
0	0																																																																																																																																																																																																																																																																																																																																																																																																																																																																																																																																																																								
	15																																																																																																																																																																																																																																																																																																																																																																																																																																																																																																																																																																								
	30																																																																																																																																																																																																																																																																																																																																																																																																																																																																																																																																																																								
	45																																																																																																																																																																																																																																																																																																																																																																																																																																																																																																																																																																								
2	60	■				■																																																																																																																																																																																																																																																																																																																																																																																																																																																																																																																																																																			
	75																																																																																																																																																																																																																																																																																																																																																																																																																																																																																																																																																																								
	90																																																																																																																																																																																																																																																																																																																																																																																																																																																																																																																																																																								
	105																																																																																																																																																																																																																																																																																																																																																																																																																																																																																																																																																																								
	120																																																																																																																																																																																																																																																																																																																																																																																																																																																																																																																																																																								
	135																																																																																																																																																																																																																																																																																																																																																																																																																																																																																																																																																																								
	150																																																																																																																																																																																																																																																																																																																																																																																																																																																																																																																																																																								
	165																																																																																																																																																																																																																																																																																																																																																																																																																																																																																																																																																																								
	180																																																																																																																																																																																																																																																																																																																																																																																																																																																																																																																																																																								
	195																																																																																																																																																																																																																																																																																																																																																																																																																																																																																																																																																																								
	210																																																																																																																																																																																																																																																																																																																																																																																																																																																																																																																																																																								
	225																																																																																																																																																																																																																																																																																																																																																																																																																																																																																																																																																																								
	240																																																																																																																																																																																																																																																																																																																																																																																																																																																																																																																																																																								
	255																																																																																																																																																																																																																																																																																																																																																																																																																																																																																																																																																																								
	270																																																																																																																																																																																																																																																																																																																																																																																																																																																																																																																																																																								
	285																																																																																																																																																																																																																																																																																																																																																																																																																																																																																																																																																																								
Version: 56																																																																																																																																																																																																																																																																																																																																																																																																																																																																																																																																																																									

Frontschild

S0.F071/A1B.PEL

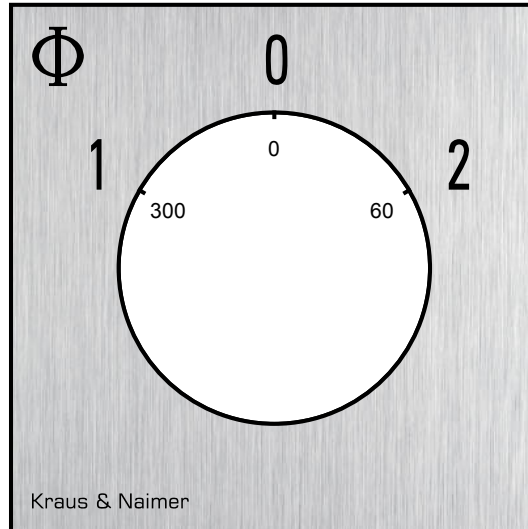

GRIFFE

Bezeichnung: S0C.G251

Grifffarbe: "1" schwarz

