









Symbolbild

Datenblatt

Artikelnummer: 70004320
Bezeichnung: CA10B.A441.GK1
Beschreibung: Schalter

IEC 60947-3 EN 60947-3, VDE 0660 Teil 107						
Bemessungsisolationsspannung Ui						
			Spannung (V) AC / DC			
			690 AC / DC			
Bemessungsdauerstrom Iu/Ith						
Strom (A)	Umgebungstemperatur (°C)	Temperaturspitzen (°C)	zusätzliche Bedingungen			
20	55	60	Umgebungstemperatur +55°C über 24 Stunden mit Spitzen bis +60°C			
Bemessungsbetriebsstrom Ie						
Gebrauchskategorie			Spannung (V)		Strom (A)	
AC-15			220 - 240		6	
AC-15			380 - 440		4	
Bemessungsbetriebsleistung						
Gebrauchskategorie	Spannung (V)	Phasenanzahl	Polanzahl	Leistung (kW)		
AC-3	220 - 240	3	3	3		
AC-3	380 - 440	3	3	5,50		
AC-3	660 - 690	3	3	5,50		
AC-3	220 - 240	1	2	2,20		
AC-3	380 - 440	1	2	3		
AC-23A	220 - 240	3	3	3,70		
AC-23A	380 - 440	3	3	7,50		
AC-23A	660 - 690	3	3	7,50		
AC-23A	220 - 240	1	2	2,50		
AC-23A	380 - 440	1	2	3,70		
Max. Sicherungsnennstrom IEC						
Sicherungscharakteristik			Sicherungsanzahl		Strom (A)	
gG			1		25	
UL60947-4-1 , UL508						
Nominal Voltage						
			Spannung (V) AC / DC			
			300 AC / DC			
Bemessungsisolationsspannung Ui						
			Spannung (V) AC / DC			
			300 AC			
Rated thermal current						
		Strom (A)	Umgebungstemperatur (°C)		Zusatz Text	
		20	0 - 40		--	
Horsepower rating						
Across-the-Line Motor Starting		Spannung (V)	Phasenanzahl	Polanzahl	Leistung (HP)	Umgebungstemperatur [°C]
Reversing		110 - 120	1	2	0,17	40
Reversing		220 - 240	1	2	0,50	40
Reversing		277 - 277	1	2	0,60	40
Reversing		110 - 120	3	3	0,50	40
Reversing		220 - 240	3	3	1	40
DOL		110 - 120	1	2	0,50	40
DOL		220 - 240	1	2	1	40
DOL		277 - 277	1	2	2	40
DOL		110 - 120	3	3	1,50	40
DOL		220 - 240	3	3	3	40
Pilot duty rating code						
Duty Code						
A300						
SCCR / Max. Vorsicherung						
Conditions of acceptability						
These devices are suitable for use on circuits capable of delivering not more than 5000 rms symmetrical amperes, 600V ac max. when protected by Class RK1 fuses. Manual Motor Controllers when intended for use as a motor disconnect are suitable for use on a circuit capable of delivering not more than 5000 rms symmetrical amperes, 600V ac max. when protected by 30A Class J time delay fuses.						
Temp. rating of wire						
			Temperature Rating (°C)		Strom (A) Text	
			60 - 75		-- Use copper wire only	
Anschlussbestimmungen						
Markings						
When intended for use as a motor disconnect the device shall be provided with a method of being locked in the OFF-position.						

General Use						
AC / DC	Spannung (V)	Strom (A)	Phasenzahl	Polanzahl	Anzahl der Kontakte in Serie	
AC	300	20	1	2	1	
AC	300	20	3	3	1	
CSA						
Nominal Voltage						
				Spannung (V) AC / DC		
				300 AC		
Bemessungsisolationsspannung Ui						
				Spannung (V) AC / DC		
				300 AC		
Rated thermal current						
		Strom (A)		Umgebungstemperatur (°C) Zusatz Text		
		20		0 - 40 --		
Horsepower rating						
Across-the-Line Motor Starting						
	Spannung (V)	Phasenzahl	Polanzahl	Leistung (HP)	Umgebungstemperatur [°C]	
DOL	110 - 120	1	2	0,50	40	
DOL	220 - 240	1	2	1	40	
DOL	277 - 277	1	2	2	40	
DOL	110 - 120	3	3	1,50	40	
DOL	220 - 240	3	3	3	40	
Pilot duty rating code						
Duty Code						
A300						
Temp. rating of wire						
				Temperature Rating (°C)		
				75		
				Strom (A) Text		
				-- only		
General Use						
AC / DC	Spannung (V)	Strom (A)	Phasenzahl	Polanzahl	Anzahl der Kontakte in Serie	
AC	300	20	1	1	1	
GENERAL TECHNICAL INFORMATION						
Leiterquerschnitt						
Leiteraufbau	Min. / Max. Wert	Anzahl der Leiter pro Klemme		Drahtquerschnitt (-bereich) (mm ²) oder (AWG/kcmil)	Drahtmaterial	
feindrähtig	Max.			2 2,5mm ²	Kupfer	
feindrähtig	Max.			2 AWG 14	Kupfer	
ein- bzw. mehrdrähtig	Max.			2 AWG 12	Kupfer	
ein- bzw. mehrdrähtig	Max.			2 2,5mm ²	Kupfer	
feindrähtig mit Aderendhülsen nach DIN 46228	Max.			2 2,5mm ²	Kupfer	
Abisolierlänge des Leiters						
			Länge (mm) Anschlusslänge - Bild			
						
Empfohlene Schraubendreher						
Schraubendreherart				Wert		
Kreuzschlitz - Schraubendreher				PH1		
Schlitzschraubendreher nach DIN 5264				0,8x4		
Klemmschraube						
				Anzugsdrehmoment (Nm)		Anzugsdrehmoment (lb-in)
				0,60		5
Approbationen						
Specification					Marking	
EAC						
CE marking						
UK Directives						
CSA C.22.2 No.14						
GB/T14048.3						
Allgemeine Informationen						
Text						
<ul style="list-style-type: none"> - Die Schaltgeräte sind wartungsfrei. Schmierung oder Behandlung von Kontakten ist zu unterlassen. - Die Schalter dürfen nur von Fachkräften und nach den anerkannten Regeln der Technik eingebaut, angeschlossen und in Betrieb genommen werden. - Nur Kupferleitungen verwenden. Leiterenden nicht verzinnen. - Klemmen mit werkseitig angeschlossenen Verbindungslaschen bzw. Drahtverbindungen werden verschraubt geliefert. Nach dem Öffnen solcher Klemmen ist darauf zu achten, dass keine Verbindungslaschen verloren gehen, alle Drahtverbindungen wieder korrekt sitzen und die Klemmschrauben mit dem angegebenen Drehmoment wieder festgezogen werden. - Nach Installation der Schalter müssen die Kriech- und Luftstrecken im Bereich der Anschlussklemmen den Anforderungen der anwendbaren Norm und Vorschriften entsprechen. 						
Waste Electrical & Electronic Equipment (WEEE)						
Picture name	Description					
	Nicht in den Müll werfen, da auf eine umweltgerechte Entsorgung und Wiederverwertung geachtet werden muss. Bitte wenden Sie sich entweder an ein umweltfreundliches Entsorgungsunternehmen; senden Sie es zur Entsorgung an den Lieferanten oder direkt an den Hersteller Kraus & Naimer zurück. Lokale Kraus & Naimer Ansprechpartner finden Sie unter www.krausnaimer.com					

Proposition 65

Bildname Beschreibung

 WARNING: This product can expose you to chemicals including nickel and lead, which is known to the State of California to cause cancer. For more information go to www.P65Warnings.ca.gov.

Kontakttype: Starre Kontaktbrücke

Kontaktmaterial: Silber

Anschluss: Schraubanschluss

Mounting-GK1

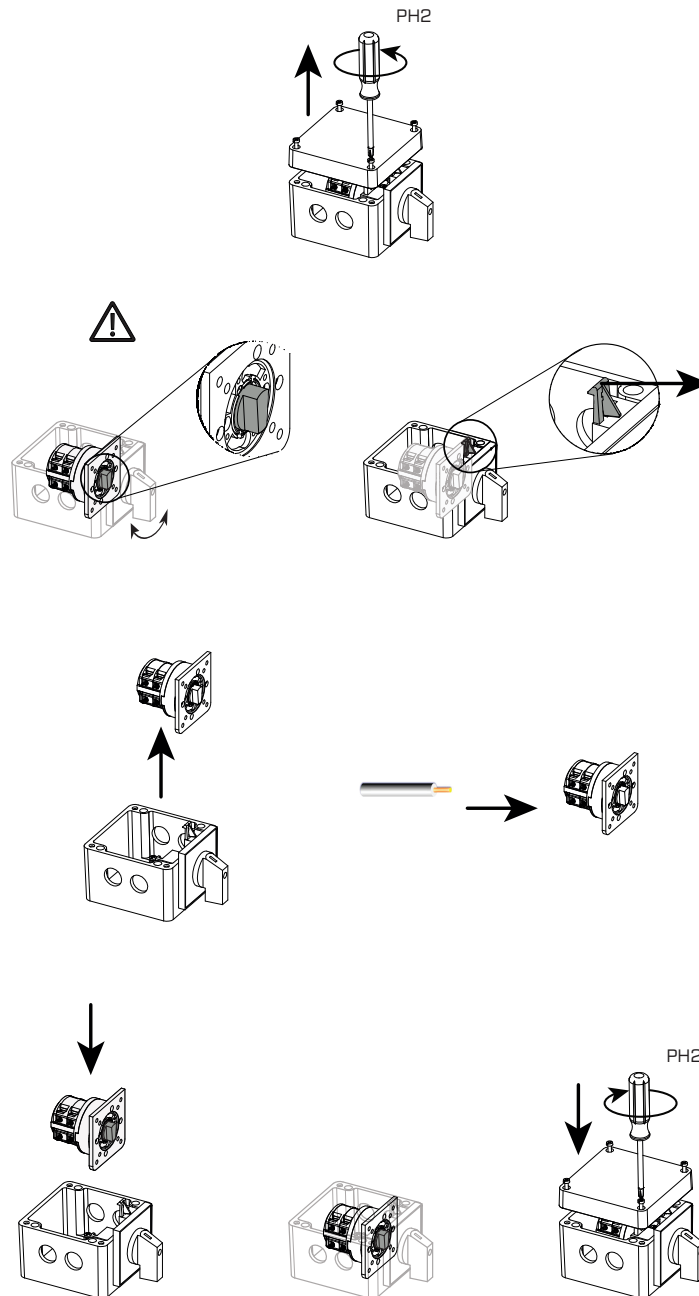

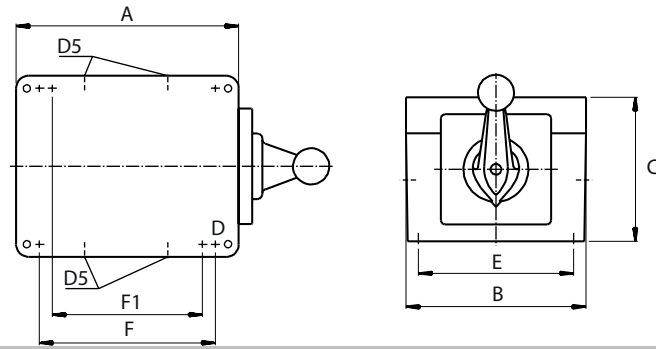

IP - Schutzart Front		IP65
Stages		1,00 - 4,00
A	H	100,00 mm
B	H	100,00 mm
C	H	80,00 mm
D	Ø	4,80 mm
D5	Ø	4,00 x M20
E	H	86,00 mm
F	H	66,00 mm

Anschlussbild

CA10B.A441.GK1

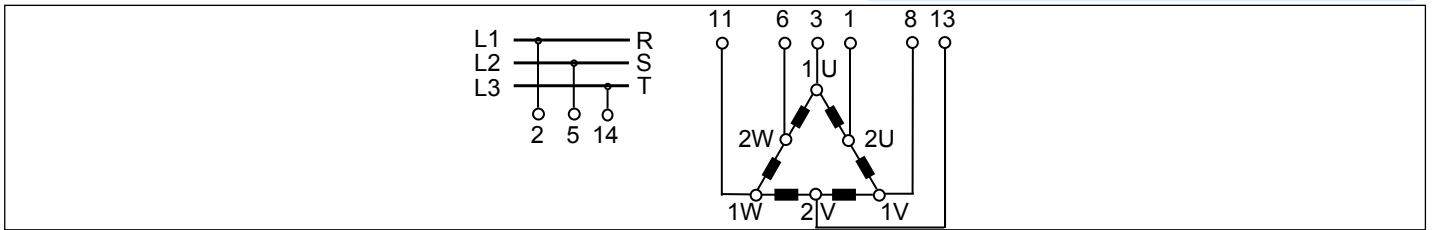

Schaltprogramm

CA10B.A441.GK1

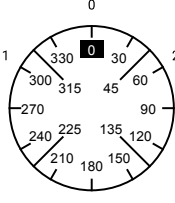
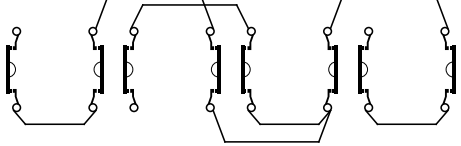
 Kraus & Naimer		CA10B		A441		Seite 1 von 1																																																																	
		Frontschild																																																																					
																																																																							
		<table border="1"> <tr> <td colspan="2">Schaltwinkel</td> <td colspan="2">60</td> <td colspan="2">2</td> <td colspan="2">4</td> <td colspan="2">6</td> <td colspan="2">8</td> <td colspan="2">10</td> <td colspan="2">12</td> <td colspan="2">14</td> <td colspan="2">16</td> <td colspan="2">18</td> <td colspan="2">20</td> <td colspan="2">22</td> <td colspan="2">24</td> </tr> <tr> <td colspan="2">Gesamtschaltwinkel</td> <td colspan="2">120</td> <td colspan="28"></td> </tr> </table>												Schaltwinkel		60		2		4		6		8		10		12		14		16		18		20		22		24		Gesamtschaltwinkel		120																											
Schaltwinkel		60		2		4		6		8		10		12		14		16		18		20		22		24																																													
Gesamtschaltwinkel		120																																																																					
1		300				■						■						■																																																					
		315																																																																					
		330																																																																					
		345																																																																					
0		0																																																																					
		15																																																																					
		30																																																																					
		45																																																																					
2		60		■		■		■		■		■		■																																																									
		75																																																																					
		90																																																																					
		105																																																																					
		120																																																																					
		135																																																																					
		150																																																																					
		165																																																																					
		180																																																																					
		195																																																																					
		210																																																																					
		225																																																																					
		240																																																																					
		255																																																																					
		270																																																																					
		285																																																																					

Version: 42

Frontschild

S1.F071/A1B.PEL

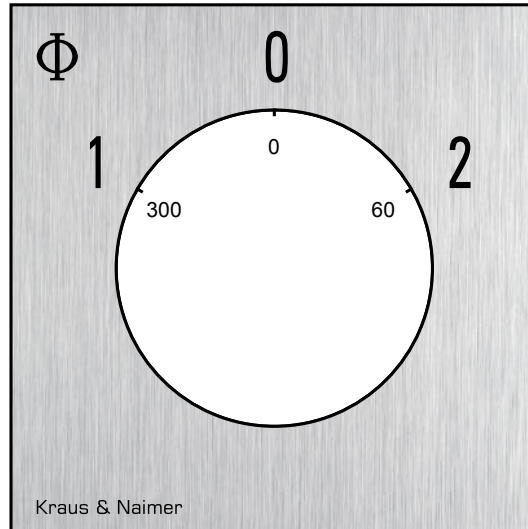

GRIFFE

Bezeichnung: S1B.G251

Grifffarbe: "1" schwarz

