





3-PHASEN-SAMMELSCHIENE,
F. 2 LEISTUNGSSCHALTER,
BGR. S2 TEILUNGSABSTAND: 75MM

Approbationen/ Zertifikate:

allgemeine Produktzulassung	Konformitätserklärung	Prüfbescheinigungen	Schiffbau
 CSA	 UL	 EG-Konf.	spezielle Prüfbescheinigungen  BUREAU VERITAS
			 RMRS

sonstiges

[Bestätigungen](#)
 [Konformitätserklärung](#)
 [sonstig](#)
 [Umweltbestätigung](#)

Weitere Informationen:

Information- and Downloadcenter (Kataloge, Broschüren,...)
<http://www.siemens.de/industrial-controls/catalogs>

Industry Mall (Online-Bestellsystem)
<http://www.siemens.de/industrial-controls/mall>

CAX-Online-Generator
<http://www.siemens.com/cax>

Service&Support (Handbücher, Betriebsanleitungen, Zertifikate, Kennlinien, FAQs,...)
<http://support.automation.siemens.com/WW/view/de/3RV1935-3A/all>

Bilddatenbank (Produktfotos, 2D-Maßzeichnungen, 3D-Modelle, Geräteschaltpläne, ...)
http://www.automation.siemens.com/bilddb/cax_de.aspx?mlfb=3RV1935-3A

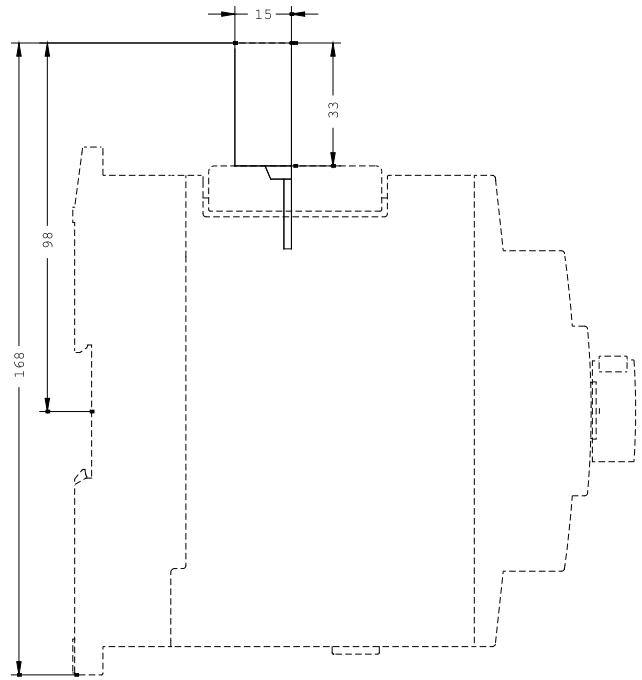
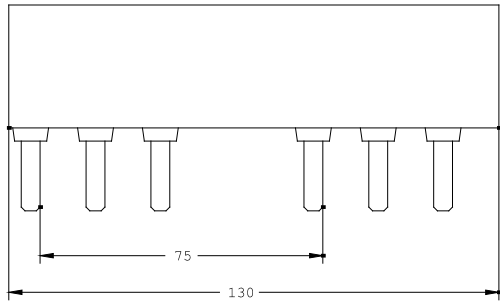

letzte Änderung: